

J1939 Bus Splitter

Product Features

- Reduces bus harnesses
- Reduces actual and production costs
- Reduces bus connections increasing quality & durability
- Eases troubleshooting of harnesses
- Potted for a true IP67 rating
- Operating & storage temp. rating -45°C to +85°C
- 2 x DT04-3P Deutsch Connectors / 6 x Nickel Plated Pins / 2 x W3P-J1939 Blue Wedge Locks
- 1 x DTF15-12P 12 pin Deutsch Connector
- Rugged ABS Housing



J1939 Bus Splitter V99-0070

This CAN bus splitter provides a cost effective and space efficient way of connecting multiple devices to the J1939 CAN bus. This module reduces cost by eliminating Y adapters and extra harnesses typically used to provide additional connections to the bus.

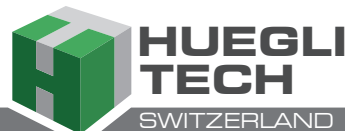
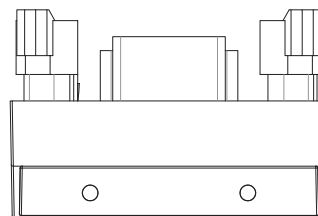
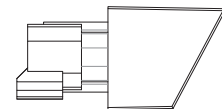
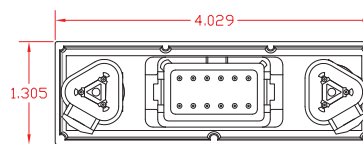
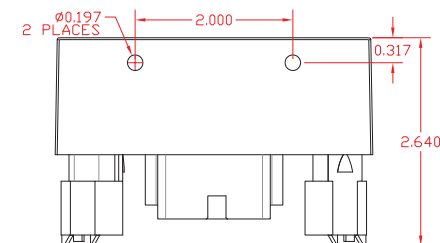
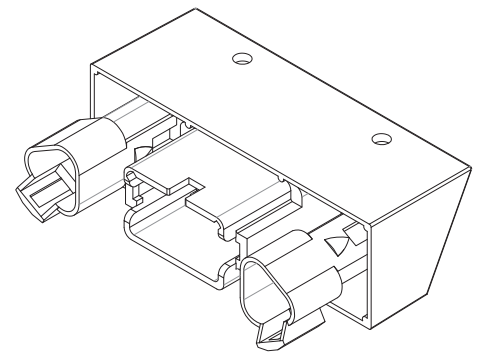
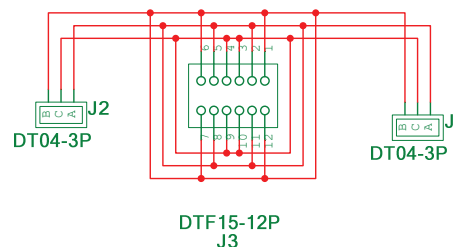

HUEGLI TECH AG (LTD)
Murgenthalstrasse 30
4900 Langenthal Switzerland
Phone: +41 62 916 50 30
Fax: +41 62 916 50 35

e-mail: sales@huegli-tech.com
www.huegli-tech.com